

SONOFF

TX IW100/101

User manual V1.1

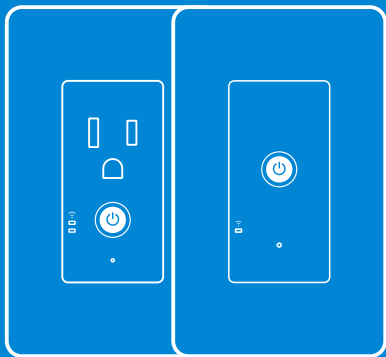

IW100

IW101

IW100: Wi-Fi Smart Wall Socket US Type

IW101: Wi-Fi Smart Wall Switch US Type

Use Instructions

1 Power off

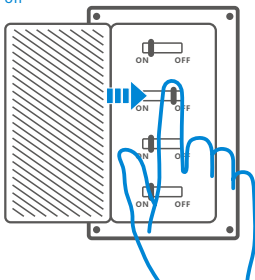

⚠ To avoid electric shocks, please consult the dealer or a qualified professional for help when installing and repairing.

2 Wiring instruction

IW100

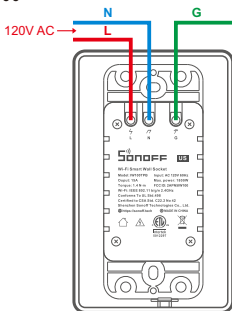

IW101

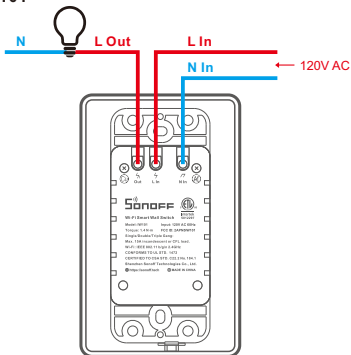

ⓘ Ensure correct wiring for live, neutral and earth wire.

3 Download the APP



4 Power on

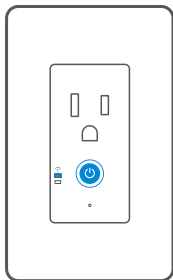

After powering on, the device will enter the quick pairing mode (Touch) during the first use. The Wi-Fi LED indicator changes in a cycle of two short and one long flash.

ⓘ The device will exit the quick pairing mode (Touch) if not paired within 3mins. If you want to enter this mode, please long press the touch switch for about 5s until the Wi-Fi LED indicator changes in a cycle of two short and one long flash and release.

5 Add the device

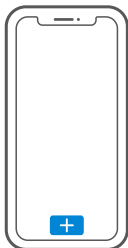

Tap "+" to operate following the prompt on the APP.

Specifications

Model	IW100TPB/IW101
Input	120V AC 60Hz
Output	15A
Max. power	1800W
Torque	1.4 N·m
Single/Double/ Triple Gang(IW101)	Max. 15A incandescent or CFL load.
lamp load(IW101)	Incandescent : 600W/120V CFL: 220W/120V
Operating systems	(Android 4.1 & iOS 9.0) or higher
Wi-Fi	IEEE 802.11 b/g/n 2.4GHz
Material	PC V0
Dimension	116x70x35mm

IW101

A cover plate approved in this report or a listed non-metallic flush cover plate shall be used when installed in the intended manner.

Strippable insulated conductor length: 8mm

Wire gauge: 12AWG

Wire quantity required: 3

Material: copper

 For control of incandescent or CFL luminaires only.

 To Reduce the Risk of Overheating And Possible Damage To Other Equipment, Do Not Install To Control A Receptacle, A Motor-Operated Appliance, A Fluorescent Lighting Fixture, Or A Transformer-Supplied Appliance.

Product Introduction

IW100

- Wi-Fi LED indicator
- On/Off LED indicator
- Configuration button
Manual switch

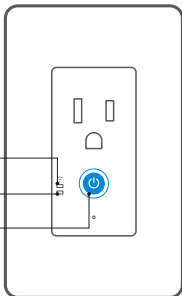

IW101

- Configuration button/
Manual switch
- Wi-Fi LED indicator

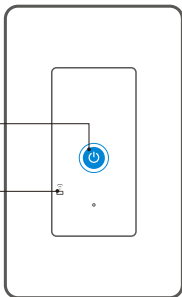

Features

Turn on/off the devices from anywhere, schedule power on/off and share devices with your family to control.



Remote Control



Timing Schedule



Voice Control



Share Control



Power Monitoring



Over-load Protection



Sync Status



Camera Feature



LAN Control

Factory Reset

Long press the configuration button for about 5s until the Wi-Fi LED indicator changes in a cycle of two short and one long flash and release, then the reset is successful. The device enters quick pairing mode (Touch).

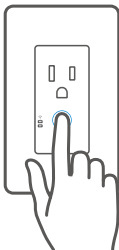

⚠ Please reset the device to factory defaults if you want to use other Wi-Fi networks, then reconnect the network.

Common Problems

Q: Why my device stays "Offline"?

A: The newly added device needs 1-2mins to connect Wi-Fi and network. If it stays offline for a long time, please judge these problems by the blue Wi-Fi indicator status:

1. The blue Wi-Fi indicator quickly flashes once per second, which means that the switch failed to connect your Wi-Fi:
 - ① Maybe you have entered a wrong Wi-Fi password.
 - ② Maybe there's too much distance between the switch your router or the environment causes interference, consider getting close to the router. If failed, please add it again.
 - ③ The 5G Wi-Fi network is not supported and only supports the 2.4GHz wireless network.
 - ④ Maybe the MAC address filtering is open. Please turn it off.

If none of the above methods solved the problem, you can open the mobile data network on your phone to create a Wi-Fi hotspot, then add the device again.

2. Blue indicator quickly flashes twice per second, which means your device has connected to Wi-Fi but failed to connect to the server.

Ensure a steady enough network. If double flash occurs frequently, which means you access an unsteady network, not the product problem. If the network is normal, try to turn off the power to restart the switch.

Scan the QR code to read the voice control instruction for Amazon Echo and Google Home.



<https://www.sonoff.tech/usermanuals>

Scan the QR code or visit the website to learn the detailed user guide.

FCC Warning

Changes or modifications not expressly approved by the party responsible for compliance could void the user's authority to operate the equipment.

This device complies with part 15 of the FCC Rules. Operation is subject to the following two conditions: (1) This device may not cause harmful interference, and (2) this device must accept any interference received, including interference that may cause undesired operation.

FCC Radiation Exposure Statement:

This equipment complies with FCC radiation exposure limits set forth for an uncontrolled environment. This equipment should be installed and operated with minimum distance 20cm between the radiator & your body. This transmitter must not be co-located or operating in conjunction with any other antenna or transmitter.

Note: This equipment has been tested and found to comply with the limits for a Class B digital device, pursuant to part 15 of the FCC Rules. These limits are designed to provide reasonable protection against harmful interference in a residential installation. This equipment generates, uses and can radiate radio frequency energy and, if not installed and used in accordance with the instructions, may cause harmful interference to radio communications. However, there is no guarantee that interference will not occur in a particular installation. If this equipment does cause harmful interference to radio or television reception, which can be determined by turning the equipment off and on, the user is encouraged to try to correct the interference by one or more of the following measures:

- Reorient or relocate the receiving antenna.
- Increase the separation between the equipment and receiver.
- Connect the equipment into an outlet on a circuit different from that to which the receiver is connected.
- Consult the dealer or an experienced radio/TV technician for help.



Shenzhen Sonoff Technologies Co., Ltd.

Room 1001, 10F, Building 8, Lianhua Industrial Park, Longyuan Road, Longhua District, Shenzhen, GD, China

Website: <https://sonoff.tech>

Service email: support@itead.cc

MADE IN CHINA

